	(IT) ISTRUZIONI DI MONTAGGIO (GB) ASSEMBLING INSTRUCTIONS (FR) NOTICE DE MONTAGE	(D) MONTAGEANLEITUNG (ES) INSTRUCCIONES DE MONTAJE (P) INSTRUCCOES DE MONTAGEM (HR) UPUTE ZA MONTAZU
	(IT) ARMADIO 6 ANTE (GB) 6-DOORS WARDROBE (FR) ARMOIRE 6 PORTES	(D) SCHRANK 6-TÜRIG (ES) ARMARIO DE 6 PUERTAS (P) ARMÁRIO DE 6 PORTAS (HR) 6-VRATA ORMAR
		

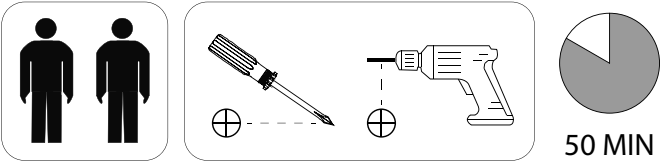
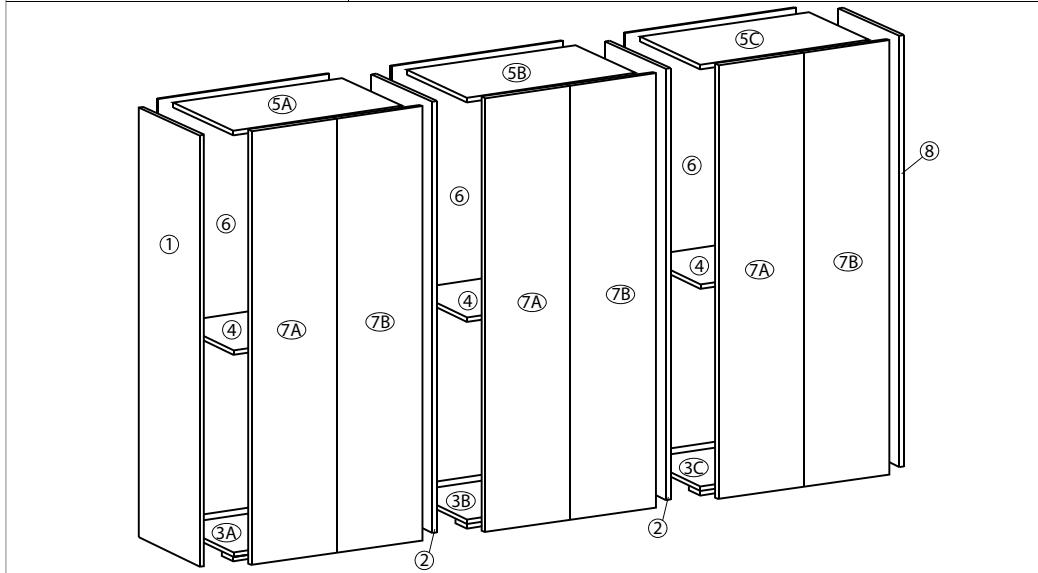
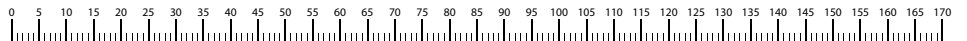

2PIFE009GR I L. 118 x 3 T 4MA x 22 x 9 G TPS 3,5x15 x 50	8SPFE4002 Q x 24 R x 24
8PIFE4001 A1 x 24 A2 x 8 B x 8 C1 x 8 C2 x 8 D x 8 E x 34 F x 16 N x 16 O x 10 P x 10 L x 12 M x 12 S x 8	

(FR) NOTICE DE MONTAGE (ES) INSTRUCCIONES DE MONTAJE (IT) FOGLIO DI ISTRUZIONI	(GB) ASSEMBLING INSTRUCTIONS (P) INSTRUCCOES DE MONTAGEM (HR) UPUTE ZA MONTAZU (D) MONTAGEANLEITUNG
Française – Suisse CONSEILS DE MONTAGE 1. Bien étudier la notice de montage; 2. Repérez les pièces constituant votre meuble; 3. Regroupez et contrôlez la quincaillerie; 4. Munissez-vous de l'outillage nécessaire; 5. Aménagez-vous une zone de montage; 6. Procédez au montage.	Ne jamais forcer les assemblages Resserrez les vis après quelques temps d'usage Garder votre notice de montage Si une pièce devait a manquer, le plus simple est de contacter votre magasin directement Le poids maximum autorisé sur les boîtes de tiroir est de 10 kg
CONSEILS D'ENTRETIEN 1. Dépoussiérez soigneusement; 2. Humecter un chiffon doux et propre d'eau légèrement savonneuse (ou détergent)	Ne jamais utiliser de produits abrasifs: poudre, laine d'acier, solvants
English ASSEMBLING ADVICE 1. Study careful the assembly instructions; 2. Characterize pieces that form the furniture; 3. Group and control the ironware; 4. Take the necessary tools for the assembly; 5. Prepare an assembly zone; 6. Proceed with the assembly.	Never force the assemblages Screw the screws after a long period Conserve the assembly instructions If one or more pieces are missing, please contact the store Maximum weight allowed on drawer boxes is 10kg.
MAINTENANCE ADVICE 1. Dust accurately; 2. Damp a cleaned and soft cloth with water and little detergent.	Do not use abrasive products: powder, steel wool, solvents
Italiano – Svizzera CONSIGLI DI MONTAGGIO 1. Studiare bene le istruzioni di montaggio; 2. Controllare che tutti i pezzi che costituiscono il mobile siano presenti; 3. Raggruppare e controllare la ferramenta; 4. Munirsi degli utensili necessari al montaggio; 5. Allestire una zona di montaggio; 6. Procedere al montaggio.	Non forzare mai gli assemblaggi Stringere le viti dopo un periodo d'uso Conservare le istruzioni di montaggio Se un pezzo dovesse mancare o essere rotto, contattare il punto vendita Il peso massima supportato dai cassetti è di 10kg.
CONSIGLI PER LA MANUTENZIONE 1. Spolverare accuratamente; 2. Inumidire con acqua leggermente insaponata uno straccio morbido e pulito.	Non utilizzare mai prodotti abrasivi: polvere, lana di acciaio, solventi
Deutsch – Schweiz MONTAGE ANLEITUNG 1. Die Montageanleitung genau durchlesen; 2. Die Einzelteile des Möbels stück ermitteln; 3. Die Beschläge zusammenlegen und prüfen; 4. Das Notwendige werkzeug zurechtlegen; 5. Einem Montagebereich freimachen; 6. Das Möbels stück zusammenbauen.	Niemals die Verbindungen zu stark anziehen Die Schrauben nach Lang Zeit des Gebrauchs erneut festziehen Die Montageanleitung gut aufbewahren Wenn ein Teil fehlen, ist Sie das beste Verständigungsmittel mit Ihrem Geschäft Das maximale Gewicht auf Schubladenkästen erlaubt ist 10 kg
PFLEGEHINWEISE 1. Sorgfältig entstauben; 2. Mit einem weichen, sauberen und feuchtem Tuch und leichter selfentaue reinigen	Benutzen Sie keine Scheuermittel wie Pulver, Stahlwolle, Lösungsmittel

(FR) NOTICE DE MONTAGE
(ES) INSTRUCCIONES DE MONTAJE
(IT) FOGLIO DI ISTRUZIONI

(GB) ASSEMBLY INSTRUCTIONS
(P) INSTRUCOES DE MONTAGEM
(HR) UPUTE ZA MONTAZU
(D) MONTAGEANLEITUNG

Español

CONSEJOS PARA EL MONTAJE

1. Estudie atentamente el manual de montaje;
2. Localice las piezas que constituyen su mueble;
3. Reuna y controle los tornillos;
4. Equipese de las herramientas necesarias;
5. Prepare una zona de montaje;
6. Realice el montaje.



No fuerce nunca en las uniones
Apriete los tornillos después de cierto tiempo de utilización
Conserve su manual de montaje
Si faltara una pieza, sea la manera más fácil de comunicarse con la tienda
El peso máximo permitido en las cajas de cajón es de 10 kg

CONSEJOS PARA EL MANTENIMIENTO

1. Despolvorear cuidadosamente;
2. Humedecer un paño suave y limpio con agua ligeramente jabonada.

No use nunca productos abrasivos tales como: polvo de limpiar, lana de acero, solventes.

Portugues

CONSELHOS DE MONTAGEM

1. Estuda bem as instruções de montagem;
2. Junta as peças que constituem o seu móvel;
3. Reagrupa e controla a quinquilharia;
4. Equipa-se da ferramenta necessária;
5. Cria-se uma zona de montagem;
6. Proceda à montagem.



Nunca esforçar as montagens
Apertar os parafusos após um tempo de utilização
Guardar as instruções de montagem, se faltara alguma peça, lo más aconsejable es contactar con la tienda
O peso máximo permitido em caixas de gaveta é de 10 kg

CONSELHOS DE MONTAGEM

1. Eliminar bem o pó;
2. Umedecer um pano suave e limpo com água e um pouco de sabão.

Nunca utilizar productos abrasivos pos, la de aço, solventes

Hrvatski

SAVJETI ZA MONTAZU

1. Porucite pažljivo upute za montazu;
2. Prekontrolirajte po uputama da li imate sve dijelove;
3. Prekontrolirajte da li imate sve vijke, matice i ostale metalne dijelove;
4. Osigurajte potreban alat za sastavljanje;
5. Oslobodite odgovarajući prostor za montiranje;
6. Ukoliko ste provjerili sve gore navedeno možete započeti montazu.



Prilikom montiranja, nemojte nasilno pokušavati spojiti dijelove
Odvijati vijke nakon dužeg stajanja montiranog proizvoda
Ukoliko Vam nedostaje koji dio, molimo Vas kontaktirati trgovinu u kojoj ste namjestaj kupili
Ladica ima nosivost od maksimalnih 10kg

SAVJETI ZA ODRZAVANJE

1. Uklanjajte redovito prašinu i nečistoće;
2. Cistite uvijek s mlom vodom i blagom deterdžentom mekom i čistom krpom.

Nemojte koristiti abrazivne krpe, pudere, metalnu vunu ili sredstva koja mogu otopiti površinu namještaja

1/7

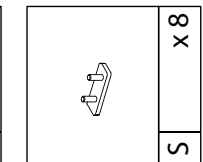
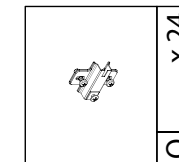
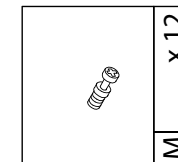
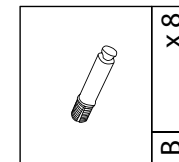
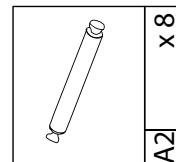
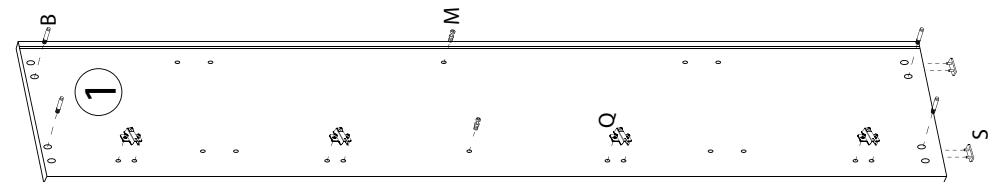
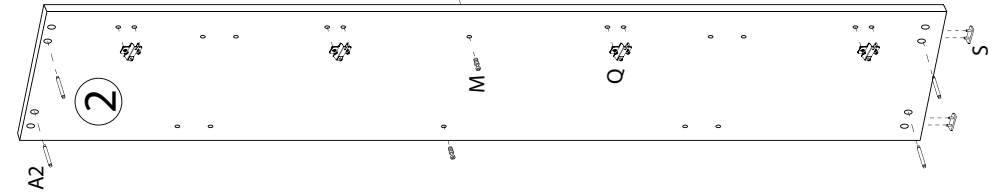
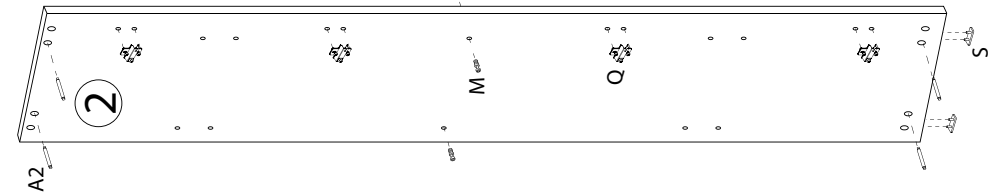
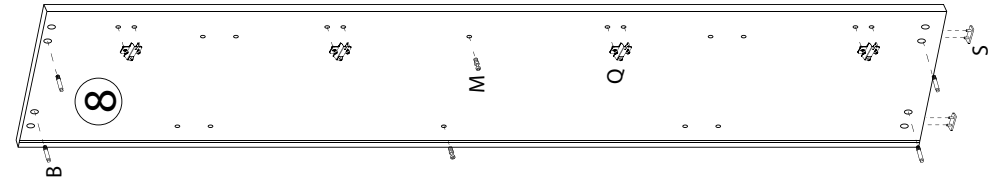

	A1	x 16
---	----	------

	C1	x 8
---	----	-----

	C2	x 8
---	----	-----

	L	x 8
---	---	-----

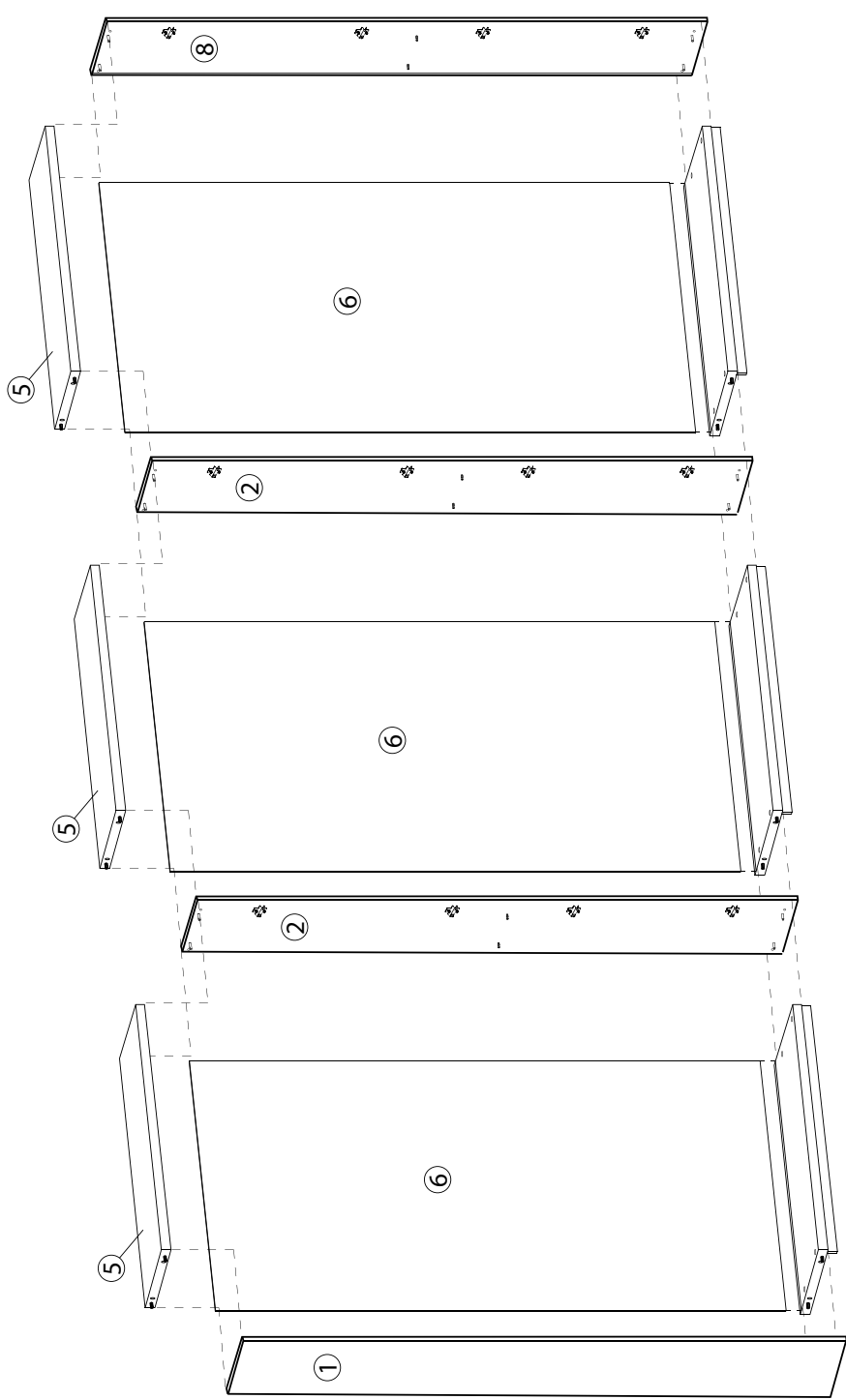
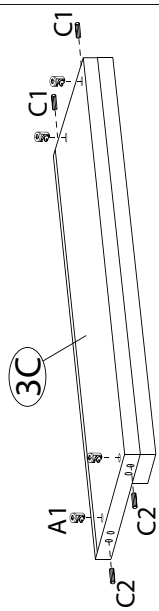
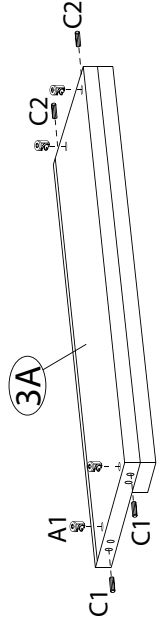
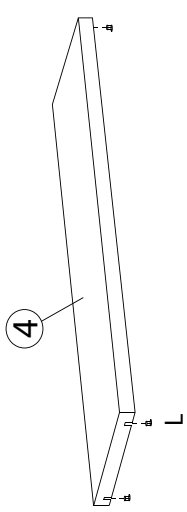
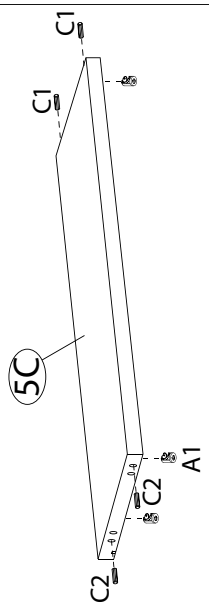
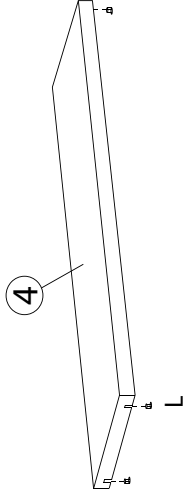
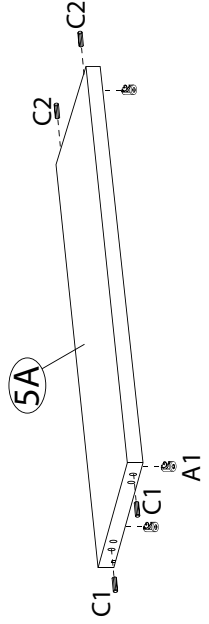

4/7

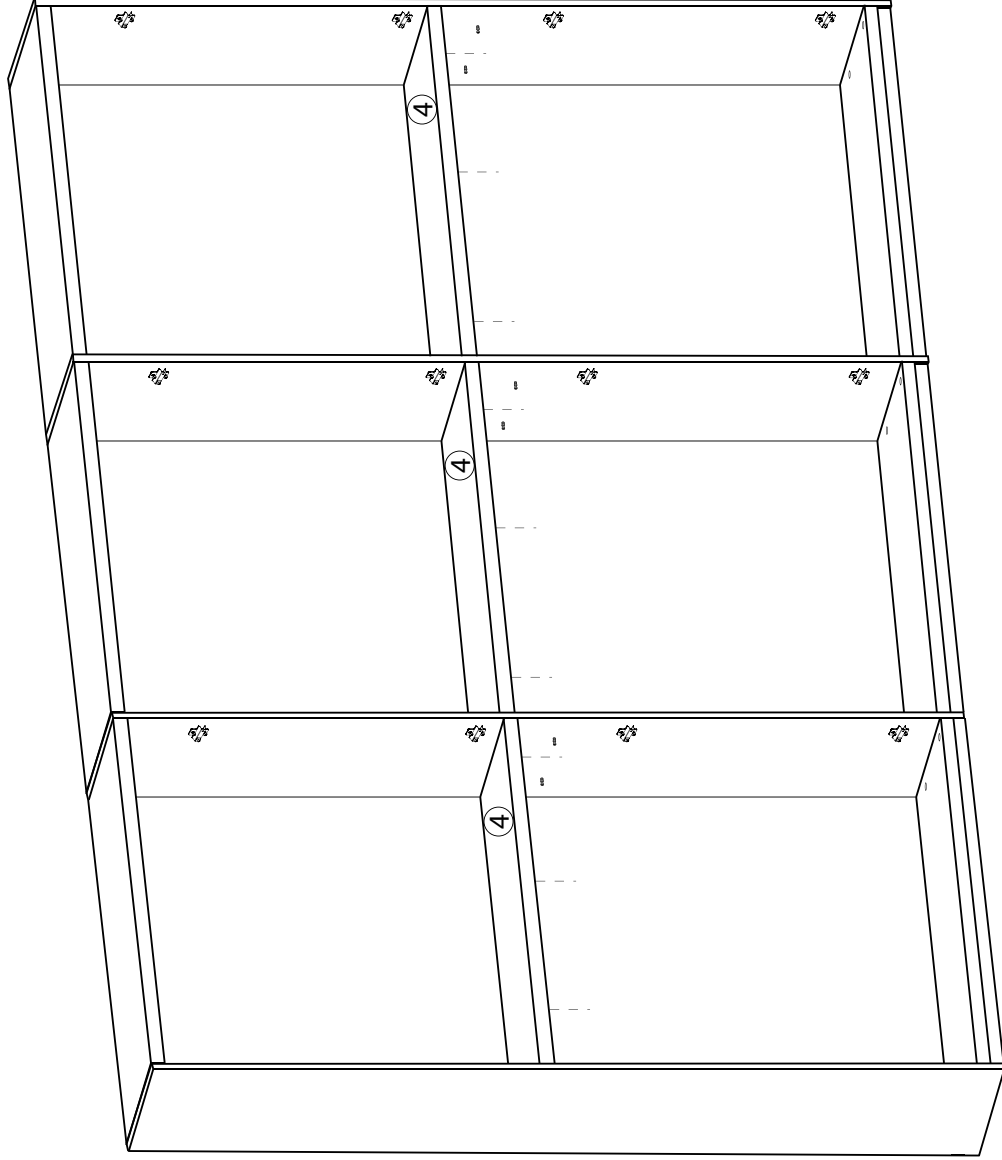

5/7

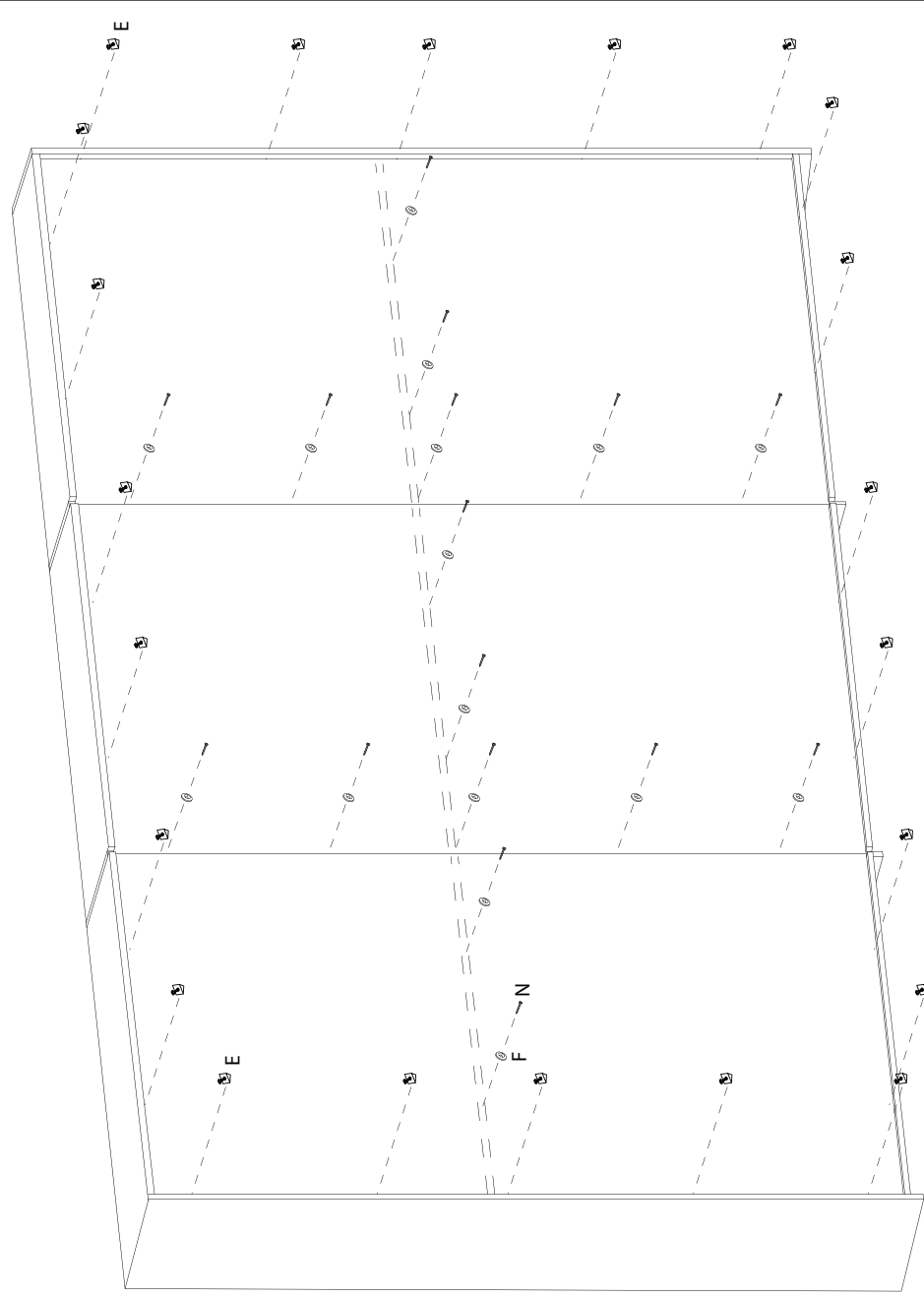

E x 34





F x 16



N TPS 3x25 x 4

	TPS 3.5x15
G	x 48

	4MA x 22
T	x 9

	L. 118
I	x 3

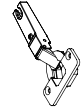
	R
R	x 24

