

# BLACK RONJA

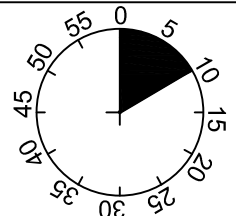

1

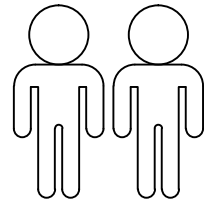
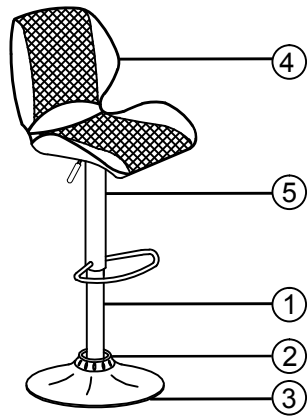
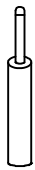

2



3



4

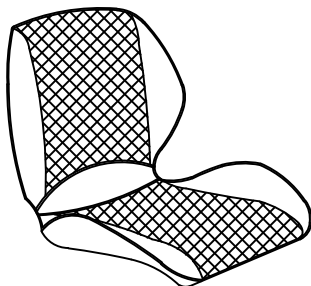

5

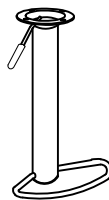

1	1x
2	1x
3	1x
4	1x
5	1x

A

M6X20



2x

B

M6x30



2x

C

Ø18xØ6x1.5



4x

D

Ø18xØ8x10



2x

E

4MM



1x

I.



1

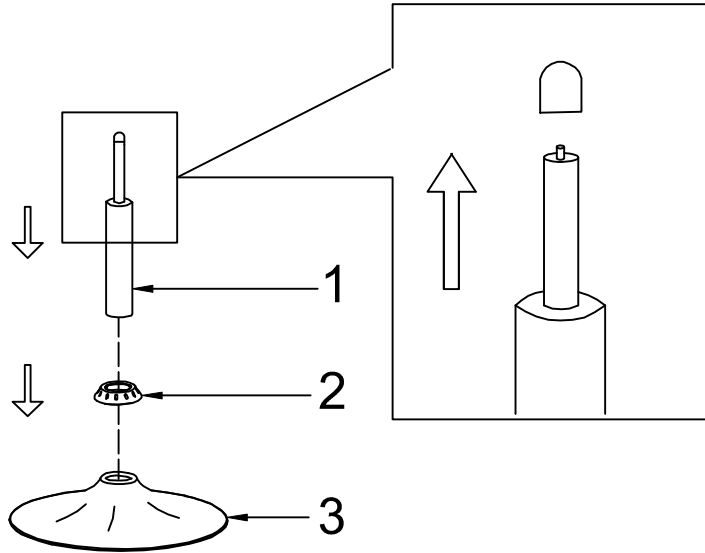

2

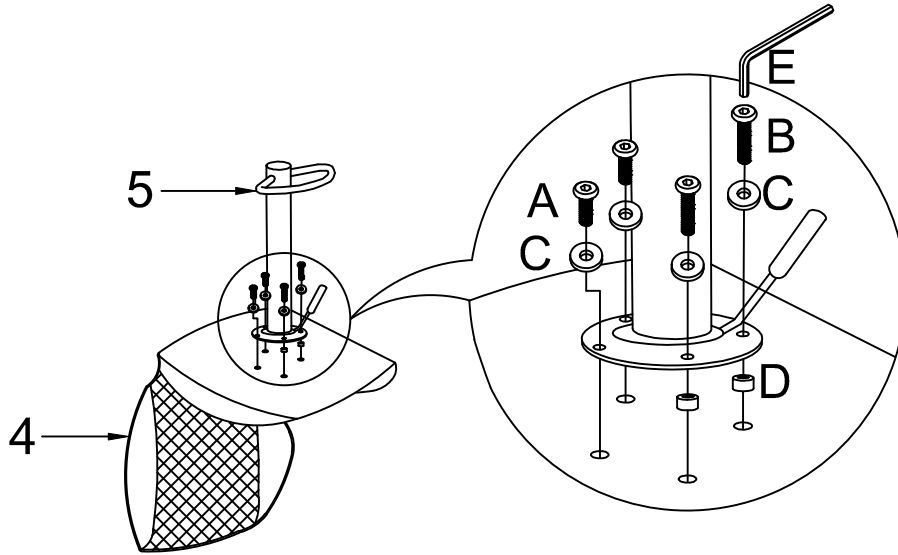

- A M6x20
- 2x
- B M6x30
- 2x
- C  $\varnothing 18 \times \varnothing 6 \times 1.5$
- 4x
- D  $\varnothing 18 \times \varnothing 8 \times 10$
- 2x
- E 4MM
- 1x



3

