

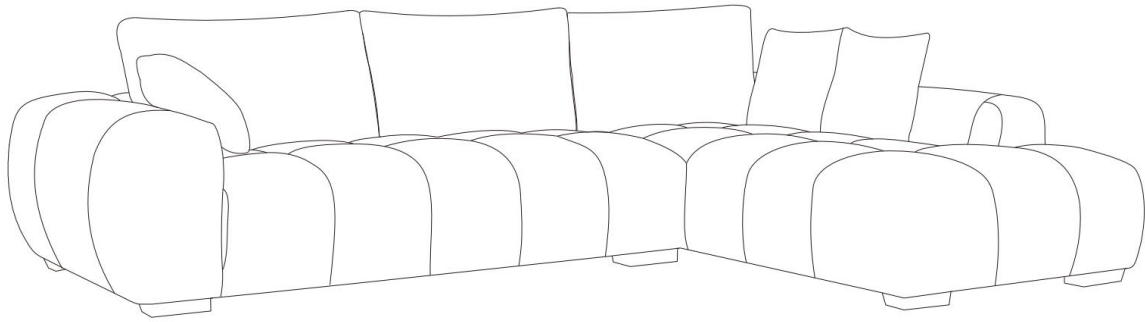



Monceau

1310_135057



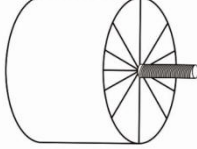

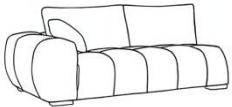
2023-2024

1310_135057				
A			X 16	1/2 AND 2/2
B		50mm	X2	1/2 AND 2/2
C		50MM	X8	1/2 AND 2/2
D		107*207*57/82	X1	1/2
E		200*104*57/82	X1	2/2



FR : SAV/INFORMATION /VIDEO/CONTACT
 EN : AFTER-SALES SERVICE/INFORMATION/VIDEO/CONTACT
 DE : REPARATUR-SERVICE UND ERSATZTEILE /INFORMATIONEN /VIDEO/KONTAKT
 ES: SERVICIO POST-VENTA/INFORMACIÓN/VIDEO/CONTACTO
 IT: SERVIZIO ASSISTENZA/INFORMAZIONI/VIDEO/CONTATTO
 PT: SERVIÇO PÓS-VENDA/INFORMAÇÕES/VIDEO/CONTATO
 PL: SERWIS TECHNICZNY/INFORMACJE/WIDEO/KONTAKT
 NE: AFTER SALES SERVICE/INFORMATIE/VIDEO/CONTACT
 HE: עם לתקשר/הווידיאו/ מידע/ומכירות שירות לאחר

SAV.HABITATETJARDIN.COM

STEP 1

- Part 1/2
- A  x8sets
 - B  x1pcs
 - C  x4pcs

Part 2/2

- A  x8sets
- B  x1pcs
- C  x4pcs

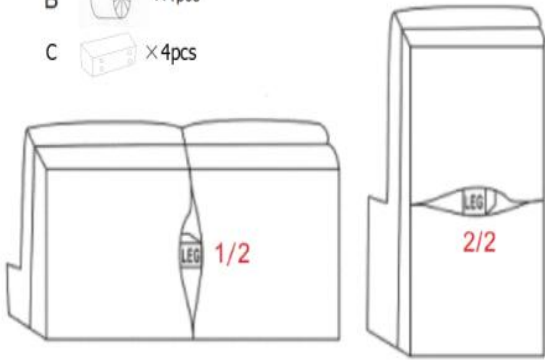

STEP 2

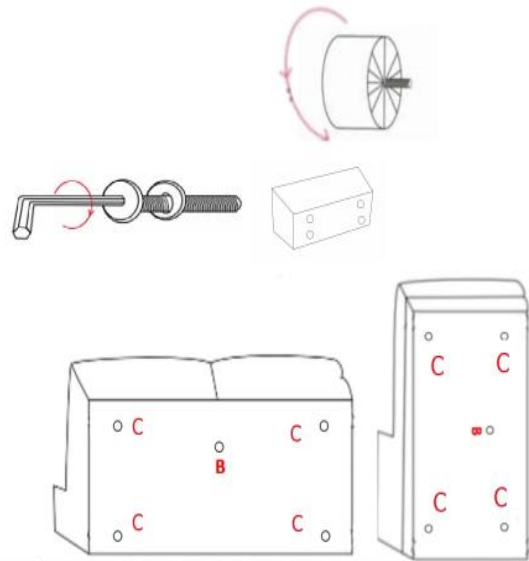

STEP 3

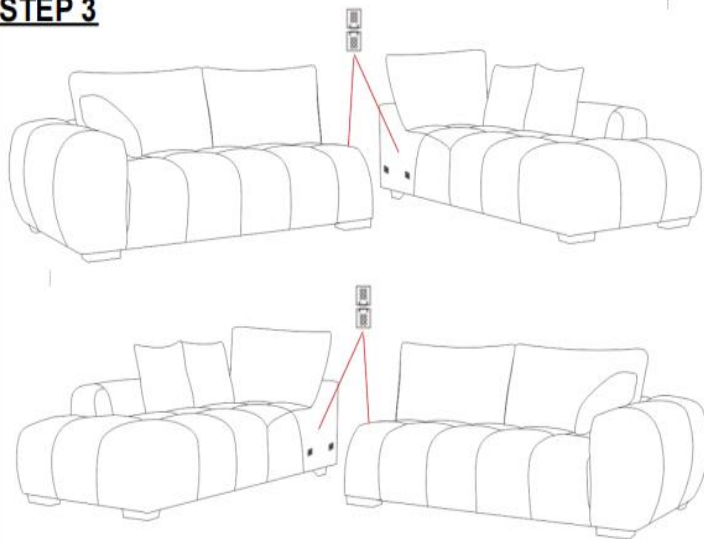

STEP 4

